

BASO 1.5 LOUVER

DIRECT / INDIRECT

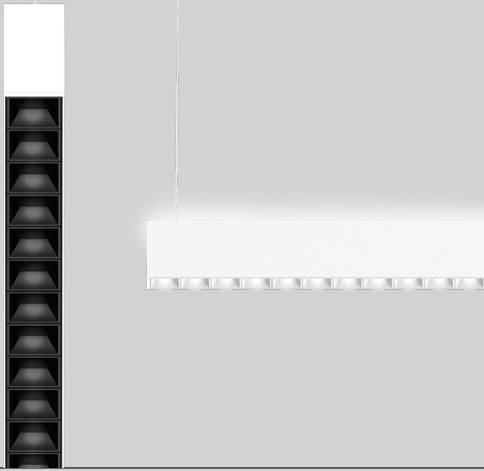

PERFORMANCE

- Up to 118lm/W efficiency
- 400 / 600 / 800lm/ft
- CRI > 80 & CRI > 90
- IC & Damp rated
- UGR < 17

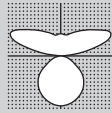

MOUNTING

Pendant



MULTIPLE LENS COMBINATIONS

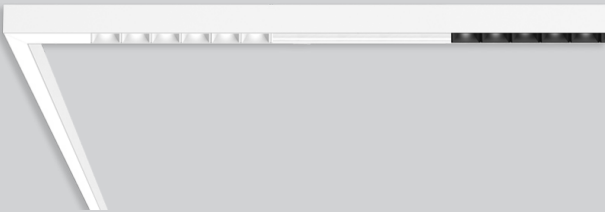

Contact customer service with a drawing of your request.

INNOVATIONS



[link to page](#)

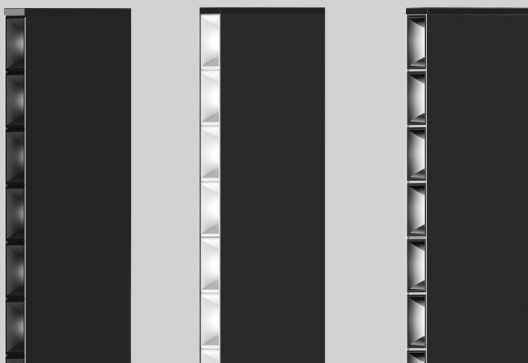

Catalog Number Example

BASO 1.5-PAT-WH-LBM-BW-30K-C80-UNV-010V-SEN-400LF-0350LF-NLC-ST-24IN

A RANGE

BASO 1.5 B A S O 1 . 5

B MOUNTING

Pendant P D T
 Pendant in-line ACT T-BAR P A T
 Pendant in-line ACT SLOT P A S
 Pendant ACT center tile P A C

pendant suspension set includes cable suspension and one white power feeder with a white junction box cover

for black power feeds or junction box covers, please contact customer service

C COLOR

White W H
 Black B L
 Gray G R
 Custom color RAL X X

trimless version available in white only

D LENS

Louver black matte L B M
 Louver black gloss L B G
 Louver white matte L W M
 Louver white gloss L W G
 Louver chrome L C H

E LENS INDIRECT

Batwing indirect B W

F CCT

3000 K 3 0 K
 3500 K 3 5 K
 4000 K 4 0 K
 Custom CCT X X K

G CRI

CRI > 80 C 8 0
 CRI > 90 C 9 0

H VOLTAGE

120V / 277V U N V

I DIMMING

0-10V 1% 0 1 0 V
 Lutron EcoSystem L E S 1
 Quantum, Vive, GRAFIK Eye,
 HomeWorks

Power over ethernet P O E C

consult customer service for compatibility

Custom dimming X X X X
 consult customer service for compatibility

J SENSOR (optional)

Integrated Sensor S E N
 consult customer service for sensor request

K OUTPUT LM/FT DOWN

400 lm/ft ↓ 0 4 0 0 L F
 600 lm/ft ↓ 0 6 0 0 L F
 800 lm/ft ↓ 0 8 0 0 L F
 Custom lm/ft X X X X L F
 custom lumen up to 800 lm/ft

L OUTPUT LM/FT UP

400 lm/ft ↑ 0 4 0 0 L F
 600 lm/ft ↑ 0 6 0 0 L F
 800 lm/ft ↑ 0 8 0 0 L F
 Custom lm/ft X X X X L F
 custom lumen up to 1000 lm/ft

M CIRCUIT / EM

Single circuit *
 EMC night light circuit N L C
 Dual Circuit D C
 * leave blank

N SHAPE / PATTERN

Linear / straight S T

O DIMENSIONS IN INCH

Linear 2' 2 4 I N
 400 lm/ft 4 8 I N
 600 lm/ft 7 2 I N
 800 lm/ft 9 6 I N
 Linear custom # # # I N

custom combinations including opal lens available, please contact customer service with a drawing of your request

P CERTIFICATION (optional)

Red List Approved R L A

BASO
 basolighting.com
 xalusa.com

Technical data

| | SIZE TYPE | LED COLOR TEMPERATURE | INPUT WATTS | DELIVERED LM TOTAL | LIGHT DISTRIBUTION | DELIVERED LM DIRECT | OPTICAL EFFICIENCY | LUMINAIRE EFFICACY |
|---------------------------------|-----------|-----------------------|-------------|--------------------|--------------------|-----------------------|--------------------|--------------------|
| BASO 1.5 LOUVER DIRECT | | | | | | | | |
| e LED | 4' linear | 30K, 35K, 40K | 16.4W | 1600lm | 100% down | 400lm/ft | 67% | 118lm/W |
| | 8' linear | | 32.8W | 3200lm | | | | |
| e ² LED | 4' linear | 30K, 35K, 40K | 25.6W | 2400lm | 100% down | 600lm/ft | 67% | 113lm/W |
| | 8' linear | | 51.2W | 4800lm | | | | |
| e ²⁺ LED | 4' linear | 30K, 35K, 40K | 35W | 3200lm | 100% down | 800lm/ft | 67% | 108lm/W |
| | 8' linear | | 70W | 6400lm | | | | |
| | | LED COLOR TEMPERATURE | INPUT WATTS | DELIVERED LM TOTAL | LIGHT DISTRIBUTION | DELIVERED LM INDIRECT | OPTICAL EFFICIENCY | LUMINAIRE EFFICACY |
| BASO 1.5 LOUVER INDIRECT | | | | | | | | |
| e LED | 4' linear | 30K, 35K, 40K | 9W | 1000lm | 100% up | 250lm/ft | 72% | 111lm/W |
| | 8' linear | | 18W | 2000lm | | | | |
| e ²⁺ LED | 4' linear | 30K, 35K, 40K | 14W | 1400lm | 100% up | 350lm/ft | 72% | 100lm/W |
| | 8' linear | | 28W | 2800lm | | | | |

Multiple lens combinations available



Patterns top view

LINEAR

| A | FIXTURES | CODE |
|------|---------------|-------------|
| 48" | 1 × 4' linear | ST - 0 4 FT |
| 96" | 1 × 8' linear | ST - 0 8 FT |
| 144" | 3 × 4' linear | ST - 1 2 FT |

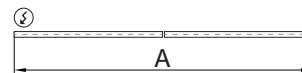

DIMENSIONS

BASO 1.5 LOUVER

PENDANT

direct direct / indirect

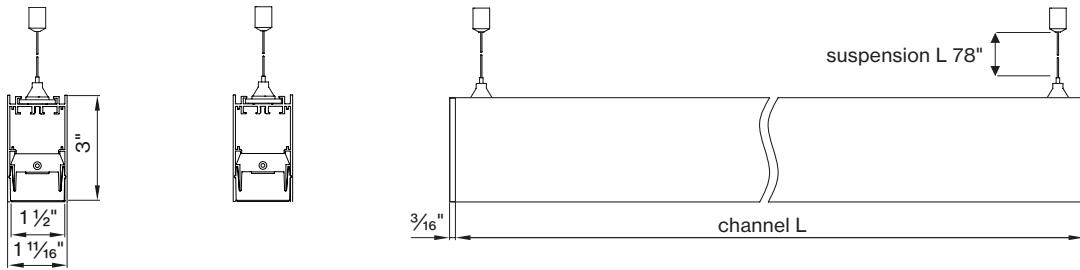

BASO 1.5 LOUVER SPECIALITY MOUNTING

SURFACE in-line ACT TBAR

SURFACE in-line ACT SLOT

SURFACE ACT center tile

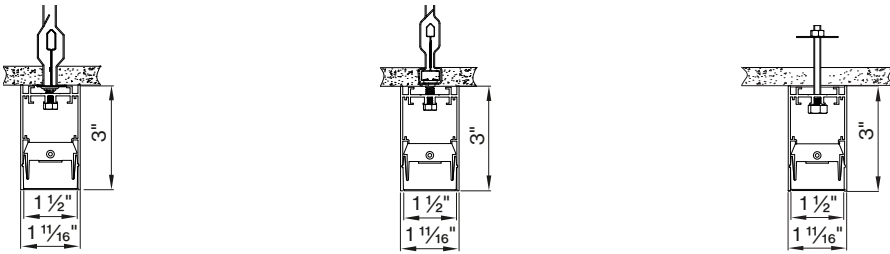

linear 4ft / 8ft

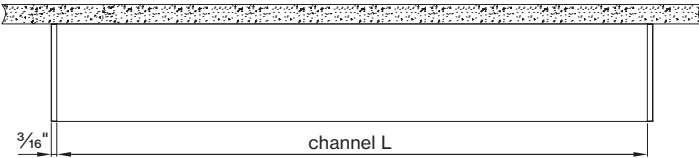

PENDANT ACT TBAR

PENDANT in-line ACT SLOT

PENDANT ACT center tile

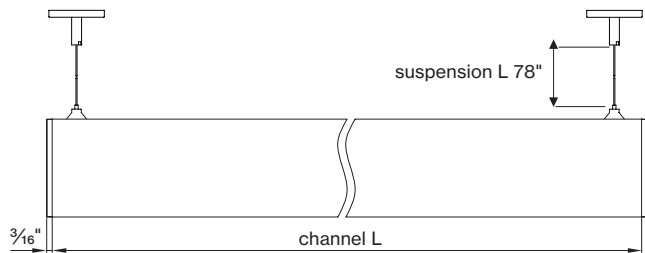
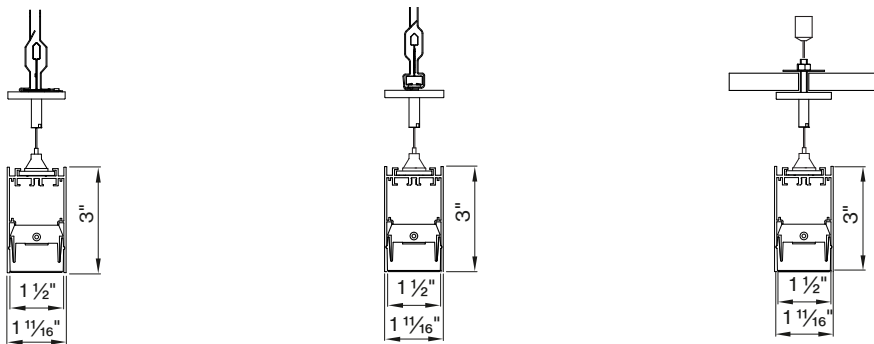

Declare.

BASO 1.5 2.5 4.0
XAL USA Incorporated

Final Assembly: United States, Connecticut, USA
Life Expectancy: 5 years
End of Life Options: Recycle (CFL), Landfill (SLN)

Ingredients:
Aluminum 2 (Polycarbonate, 2-methyl-2-butene), methyl ester polymer with ethyl-2-cyanoacrylate from ethylacrylate, ethylacrylate, Center Material (CFL), Polyethylene Glycol (methyl methacrylate), Polypropylene, ethylacrylate, Acrylonitrile (Ethylacrylate), Copper wire (EFL, Recycled), Solving (EFL)

*LAC Temp Exception RE-002 - Small Electrical Components

Living Building Challenge Criteria

100% Recycled
LBC Red List Free 1% Chlorofluorocarbons (CFCs) at 100ppm
LBC Red List Approved VOC Content: Not Applicable
Copper 100% Recycled
100% Recycled 100% Recycled
100% Recycled 100% Recycled

File: 0320
EXP of March 2024
Original Issue Date: 2023

Environmental Living Building Institute™ www.livingbuildinginstitute.com

BASO mounting instructions

Get access to the BASO 1.5 LOUVER mounting instructions faster by scanning the QR code.



www.xalusa.com/resources/mounting-instructions/baso